



>Welcome
#MyDurhamFuture

1832

Established in 1832

**3rd oldest university in
England**

**Located in North East
England with a beautiful
UNESCO World Heritage
Site**

Member of Russell Group



**Durham
University**

100

World Top 100 University
(QS World Ranking, 2021)

5th in the UK
(The Guardian, 2020)

**Over 90% of our subjects
are ranked in the top 10
nationally**
(Complete University Guide, 2019)

19,367

**19,367 students
registered at Durham,
which included:**

**14,604 undergraduate
2,955 postgraduate taught
1,554 postgraduate
research
254 postgraduate
distance learning**

**33% international
students from over 156
different countries
(20% Asian, 15% from
mainland China)**



17

**17 distinct colleges
where our students eat, sleep,
and socialise.**

**Somewhere to make new
friends, try new experiences,
and build new skills.**

**Excellent facilities: café, shop,
library, chapel, study space,
gym, and more.**

**Guaranteed first year
accommodation.**

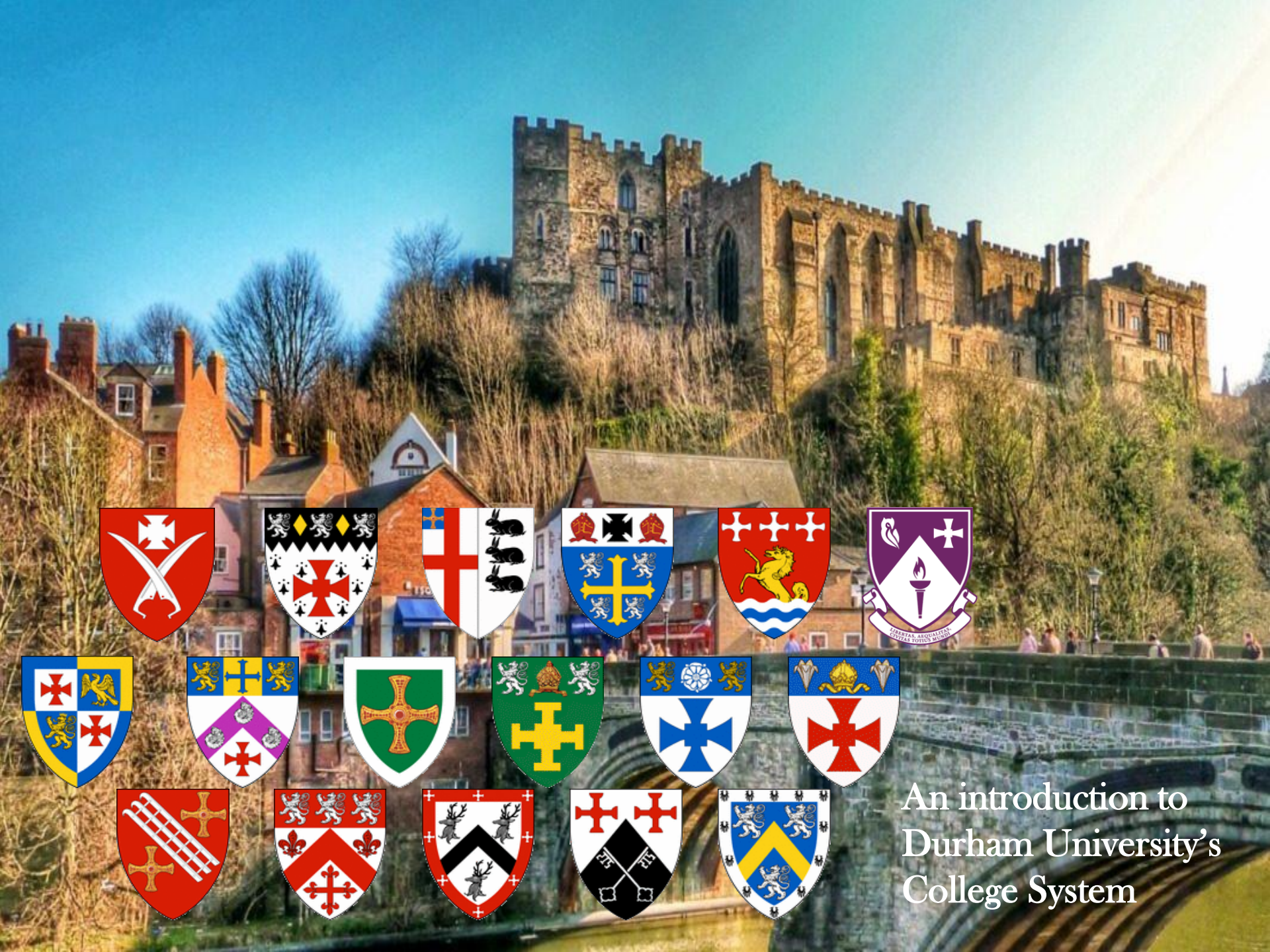

An introduction to
Durham University's
College System

College life

Student-organised social events are a big part of College life. Events include;

- Musical & theatrical evenings e.g. Shakespeare productions, open-mike nights
- Annual summer & winter balls
- Formal dining events – ‘formals’
- Annual ‘College Day’



200

200+ Clubs and Societies

90%+ of our students take part in sport and societies, including **400** teams across 15 different sports.

60 student theatre productions every year.

Students raising money for over **120** charities.
Volunteering opportunities with over **40** local projects.

240

**240+ exchange agreements
for undergraduate students
to study abroad.**

**Partner institutions spread
across the globe from
Austria to New Zealand!**

**Every academic programme
offers opportunities for
students to study or work
abroad through Erasmus,
Study Abroad or Exchange.**

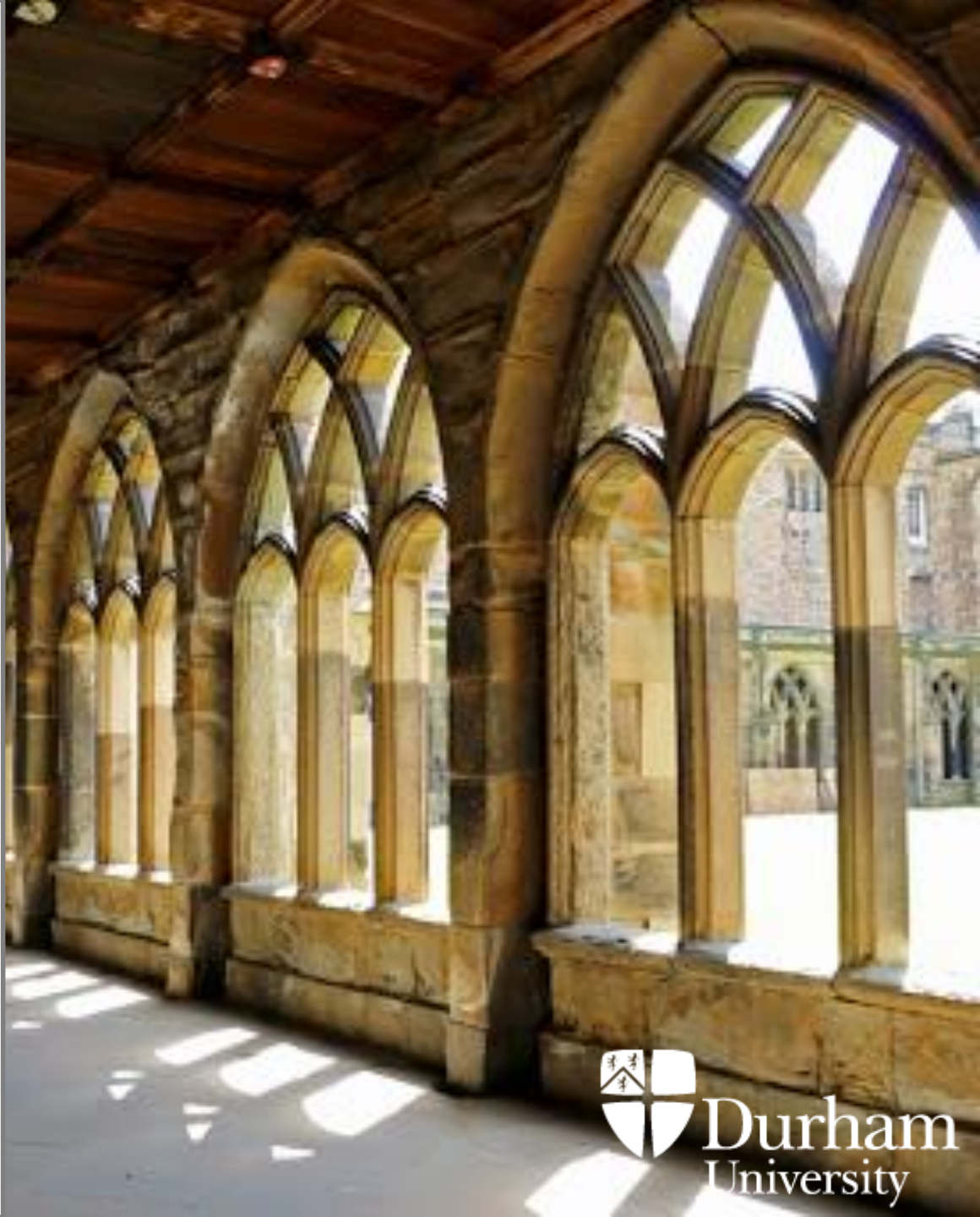

Durham
University

20 Minute Society	American Dance	Croquet	Left Handed Society	Rock Society
A Capella Choir	Band Society	Cypriot Society	LEGO Society	Satire Society
ActionAid Society	Barnardos	Dancesport	LGBTQ Association	Science Fiction Society
Aerial Arts	Belly Dancing Society	DJ Society	LINKS Society	Scout and Guide Group
Aerobics Society	Big Band	Documentary Society	Made in America	Scuba Diving Society
African & Caribbean Society	Biological Society	Duke of Edinburgh's Award DULOG	Magic Society	Shorinji Kempo
African Singing & Drumming	Book Club	Durham Globalist Magazine	Manga and Anime Society	Singapore Society
AIIESEC	Breakdance	Durham Student Film	Marketing Society	Skills Exchange Society
Aikido Club	Bridge Club	Durham Student Theatre	Marxist Society	Speleological Association
Alternative Music Society	Bruneian Society	Economics Journal	Mathematical Society	Stop the Trafficking
Amnesty International	Buddhist Society	Economics Society	Medical Aid Society	Swing Society
Angling Society	Business Society	Engineers Without Borders	Meditation Society	Tea, Coffee & Cake Society
Anglo-Japanese Society	Caledonian Society	E-Sports	Methodist Society	TEDx
Animal Rights & Welfare	Calisthenics	Feminism Society	Mock Trial Society	Tenteleni Society
Anthropology Society	CARA	Folk Society	Mooting Society	Thai Boxing
Archaeology Society	Catholic Society	Freefall	Natural Sciences Society	Thai Society
Argentine Tango	Change Ringers	Friends of Palestine	Orchestral Society	Together Against Ebola
Art Society	Chess Society	General LARP	Origami Society	Treasure Trap
Arthur Holmes Geological Society	Chinese Debating Society	Geographical Society	Oxfam Society	Underwater Hockey Society
Assassins' Society	Chocolate Society	Gin Society	Palatinate	UKIP Group
Artificial Intelligence	Choral Society	Gliding Society	People and Planet	UNICEF Society
Astronomical	Christian Union	Gospel Choir	Philharmonia Society	United Nations Society
Atheists & Secularists	Cider Society	Harry Potter Society	Philosophical Society	Vegetarians and Vegans
Baking	Classical Ensemble	Hill Walking	Photography Society	Weightlifting & Bodybuilding
Banquet	Classics Society	Hummus	Physics Society	Welsh Society
Barnardos	Cocktail Society	Improvised Comedy	Poetry Society	Whisky Appreciation Society
Belly Dancing Society	Computing Society	International Development	Pokémon Society	Women in Business
Big Band	Conservation Society	Islamic Society	Poker Society	
Biological Society	Conservative Association	It Happens Here	Pole Dancing	
Book Club			Psychology Society	
Breakdance			Purple Radio	
Bridge Club				
Bruneian Society				
Buddhist Society				
Business Society				
Caledonian Society				
Calisthenics				
CARA				
Catholic Society				
Change Ringers				
Chemical Society				
Chess Society				
Chinese Debating Society				
Chocolate Society				
Choral Society				
Christian Union				
Cider Society				
Classical Ensemble				
Classics Society				
Cocktail Society				
Computing Society				
Conservation Society				
Conservative Association				
Croquet				
Cypriot Society				
Dancesport				
DJ Society				
Documentary Society				
Duke of Edinburgh's Award DULOG				
Durham Globalist Magazine				
Durham Student Film				
Durham Student Theatre				
Economics Journal				
Economics Society				
Engineers Without Borders				
E-Sports				
Feminism Society				
Folk Society				
Freefall				
Friends of Palestine				
General LARP				
Geographical Society				
Gin Society				
Gliding Society				
Gospel Choir				
Harry Potter Society				
Hill Walking				
Hummus				
Improvised Comedy				
International Development				
Islamic Society				
It Happens Here				
Left Handed Society				
LEGO Society				
LGBTQ Association				
LINKS Society				
Made in America				
Magic Society				
Manga and Anime Society				
Marketing Society				
Marxist Society				
Mathematical Society				
Medical Aid Society				
Meditation Society				
Mental Wealth				
Methodist Society				
Mock Trial Society				
Mooting Society				
Natural Sciences Society				
Orchestral Society				
Origami Society				
Oxfam Society				
Palatinate				
People and Planet				
Philharmonia Society				
Philosophical Society				
Photography Society				
Physics Society				
Poetry Society				
Pokémon Society				
Poker Society				
Pole Dancing				
Psychology Society				
Purple Radio				
Rock Society				
Satire Society				
Science Fiction Society				
Scout and Guide Group				
Scuba Diving Society				
Shorinji Kempo				
Singapore Society				
Skills Exchange Society				
Speleological Association				
Stop the Trafficking				
Swing Society				
Tea, Coffee & Cake Society				
TEDx				
Tenteleni Society				
Thai Boxing				
Thai Society				
Together Against Ebola				
Treasure Trap				
Underwater Hockey Society				
UKIP Group				
UNICEF Society				
United Nations Society				
Vegetarians and Vegans				
Weightlifting & Bodybuilding				
Welsh Society				
Whisky Appreciation Society				
Women in Business				

40th

**Top 40th in the world for
Employer Reputation**
(QS World Rankings, 2020)

**9th in the UK for graduate
prospects**
(The Good University Guide 2017)

**Fantastic career support,
internships and
development for your
future career.**

Updates

New Rankings

Three subjects in the World Top 10 – Theology & Religion (4th), Archaeology (4th) and Geography (10th) and 17 subjects ranked in the World Top 100 QS World rankings by subject (2020)

English & Music ranked 1st in UK – Complete University Guide (2019)

Durham ranked 6th in the UK – Complete University Guide (2019)

Durham's Art & Humanities programmes 30th globally – THE (2019)

Social Sciences & Law both ranked in top 50 globally – THE (2019)

Durham's MBA ranked in Global top 50 – Financial Times (2019)

Campus map

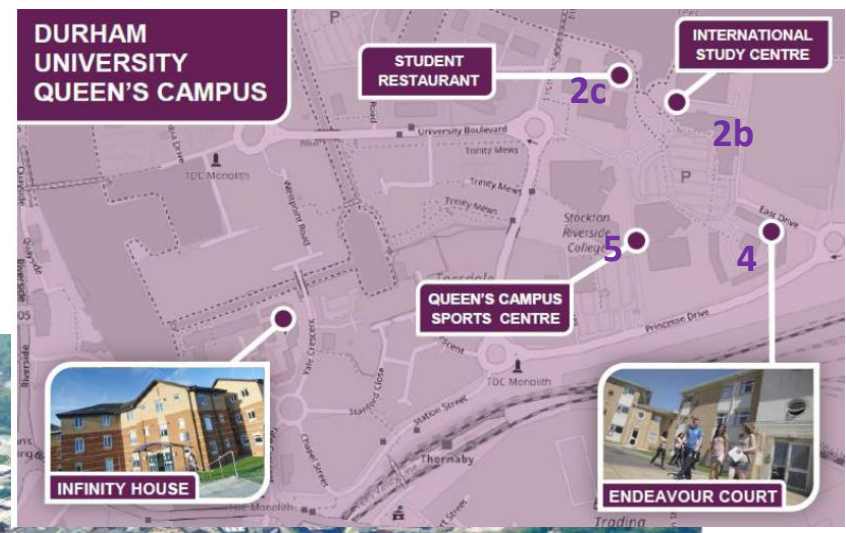

- | | | | |
|-------------------------|------------------------------------|---------------------------------|-----------------------------------|
| 1. Teesside Retail Park | 2c. Holiday Building | 5. Queen's Campus Sports Centre | 7. Infinity House (accommodation) |
| 2a. Ebsworth Building | 3. Infinity Bridge | 6. Thornaby Railway Station | 8. Stockton Town Centre |
| 2b. Wolfson Building | 4. Endeavour House (accommodation) | | |

International Foundation Year

Pathways and tuition fee

- Business, Economics, Accounting and Finance
- Humanities, Law and Social Science
- Science and Engineering

• **Course length:** 3 terms

• **Intakes:** September and January

Entry requirements

• **Academic:**

Senior High 3 – 60%

Senior High 2 – 75%

• **English language:** Academic IELTS for UKVI 5.5 (5.5 in reading and writing, 5.0 in all components)

• **Age:** 17+

IELTS	Length	Jun	Aug	Sep	Dec	Jan	Apr	Jun	Aug	Oct	
5.0*	4 terms										Start your degree
5.0*	4 terms										
5.5**	3 terms										
5.5**	3 terms										

*5.0 in reading and Writing, 4.5 in all other skills

**5.5 in reading and Writing, 5.0 in all other skills

	International Foundation Year		English Language Preparation
--	-------------------------------	--	------------------------------

What you can expect at the International Study Centre

A full induction programme in the first week of term

- Find out about your course, get your timetable and meet your tutors
- Get help with opening your bank account, obtaining your Biometric Residents Permit, and registration.
- Take part in lots of social activities so you can have some fun and make friends.

Support to succeed in your studies

- A personal tutor who you will meet with regularly to discuss your progress.
- Departmental link tutors will visit the ISC to speak about your chosen degree area.

Help with choosing your college

- You are guaranteed accommodation in one of Durham's 15 colleges when you progress (for the first year), and you will select your '*preference*' by the end of January.
- Visits will be organised to Durham to help you understand the college system.

Social and sporting activities

- Be a part of social events planned throughout the year.
- Join a sports team and get involved, or organise your own – 5-a-side football for example.



Thank you!



Feel free to contact me through Facebook, Instagram, Line or any social media!

It'll be great if you can contact me through UniBuddy !

英國留學分享—Sheffield

陳昶全 Benjamin Chen



自我介紹



名字：陳昶全

英文名：Benjamin Chen

學校：University of Sheffield

科系：Mechatronic with Robotic Engineering

職業：工讀 RD - 揚帆興業股份有限公司

Email: b509061212@gmail.com

Sheffield Uni 位置

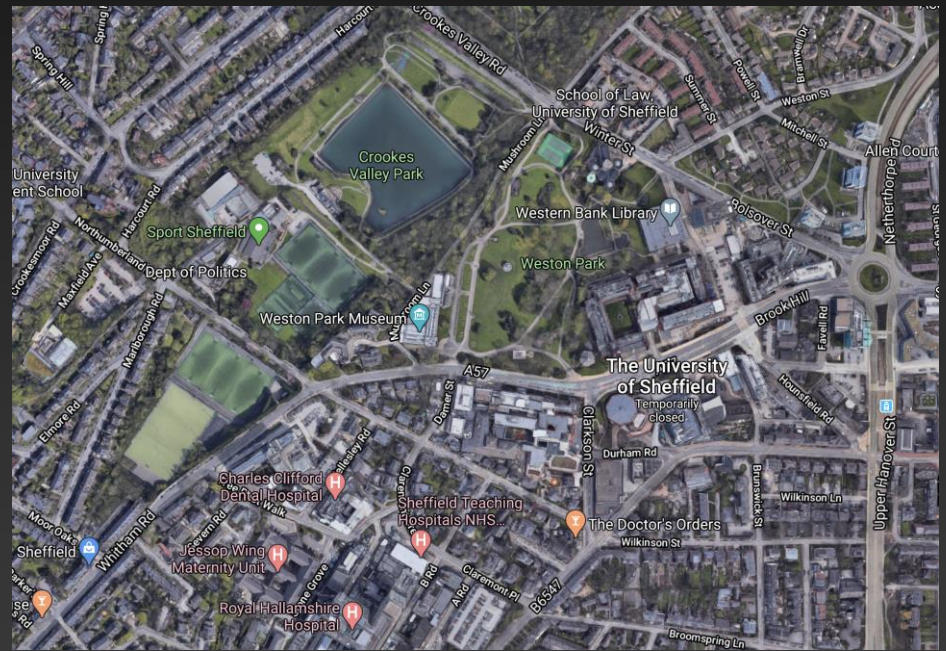
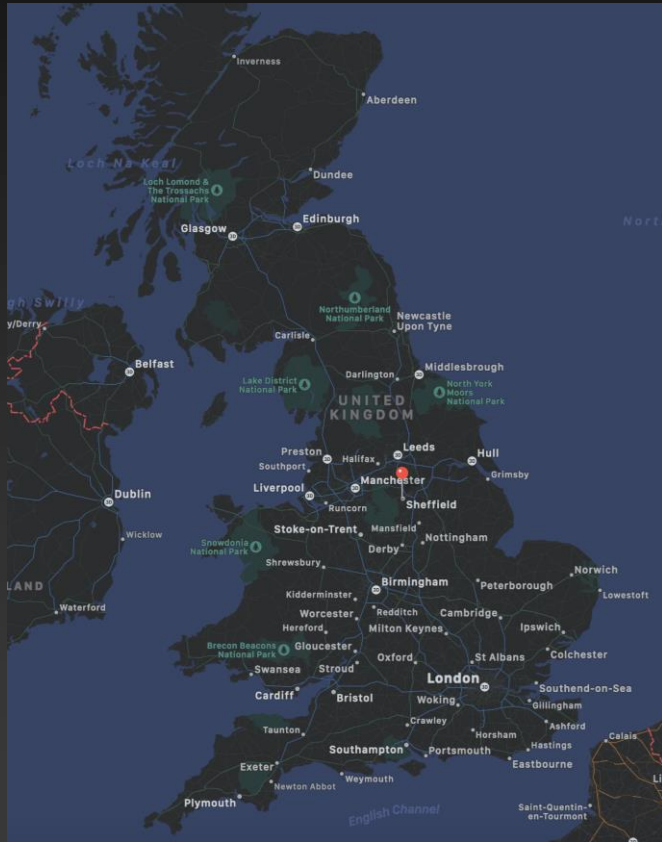

Faculty of Engineering







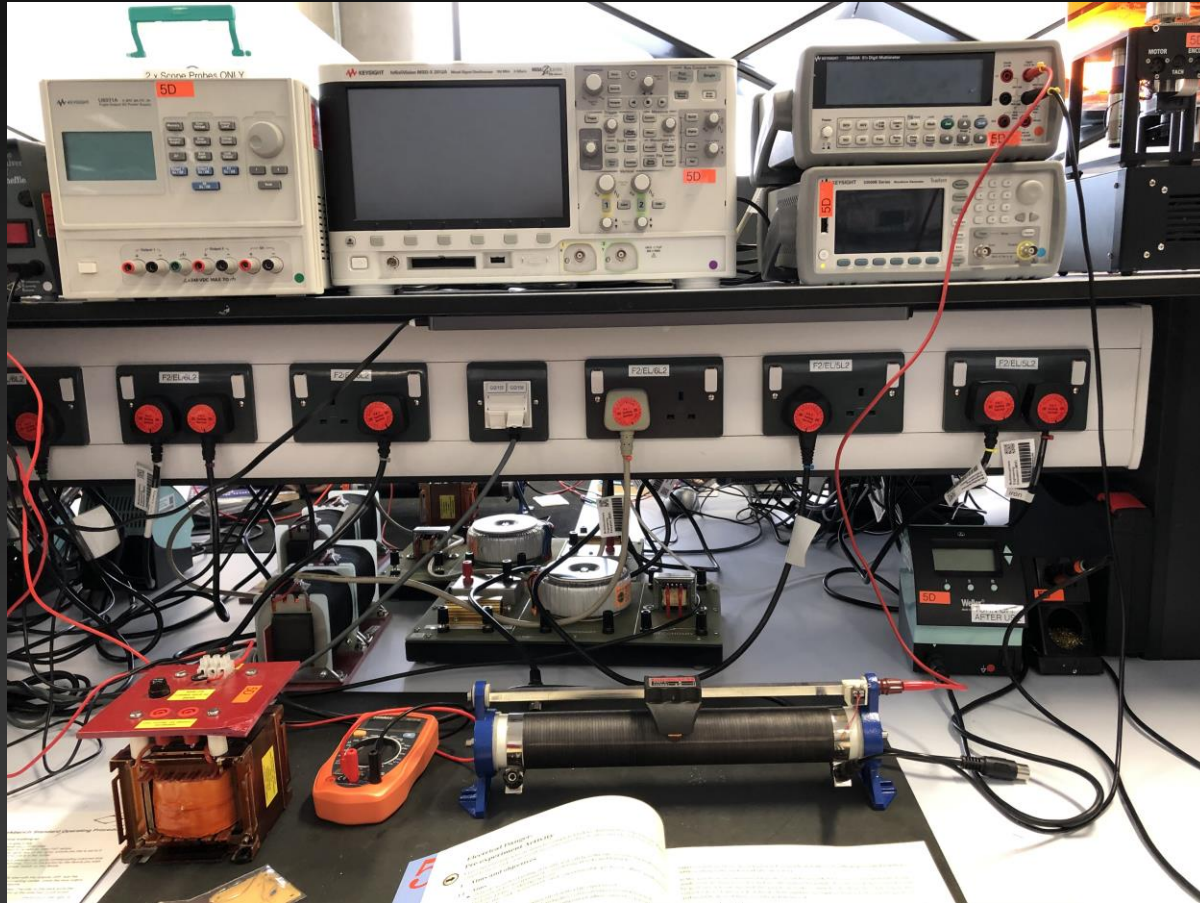

Student Union



課外活動







學習心態—分享

1. 成果是藉由討論出來的
2. 學習發問的關鍵點
3. 保持積極的態度
4. 不要抄作業！！！！
5. Feedback 的重要性
6. 培養解決問題的能力

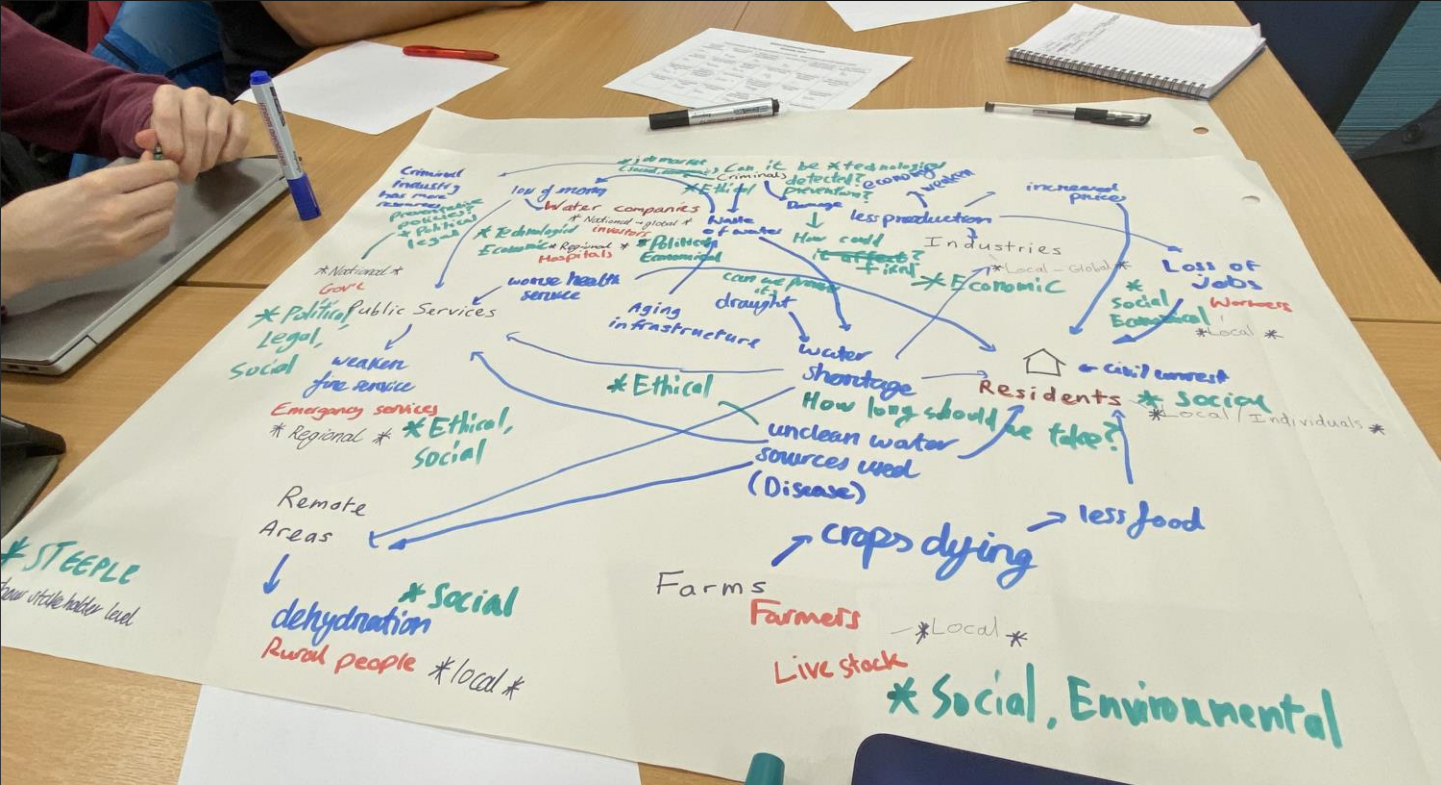

學習心態—分享

1. 成果是藉由討論出來的
2. 學習發問的關鍵點
3. 保持積極的態度
4. 不要抄作業！！！！
5. Feedback 的重要性
6. 培養解決問題的能力

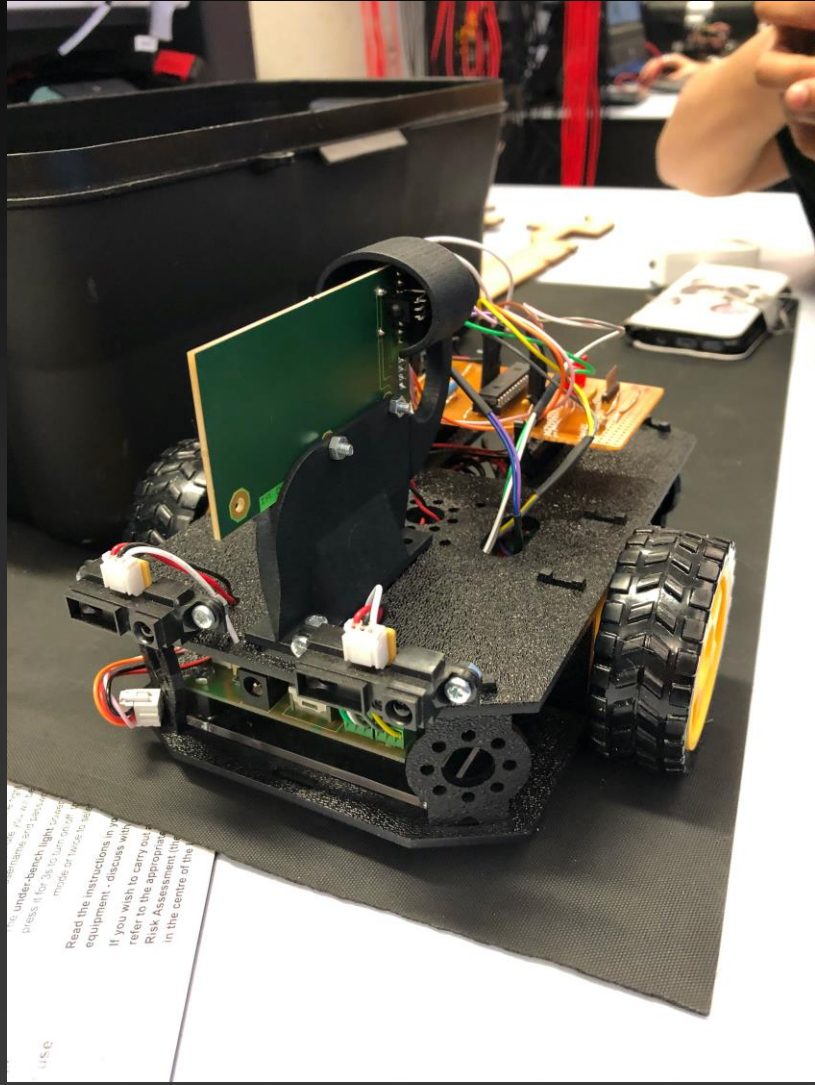

USE

Under each light microscope please fill in the appropriate boxes on the form of Microscopy

Read the instructions in the equipment - discuss with your partner and refer to the appropriate Risk Assessment in the Centre of the

* Board editor (robot-new.vbd)

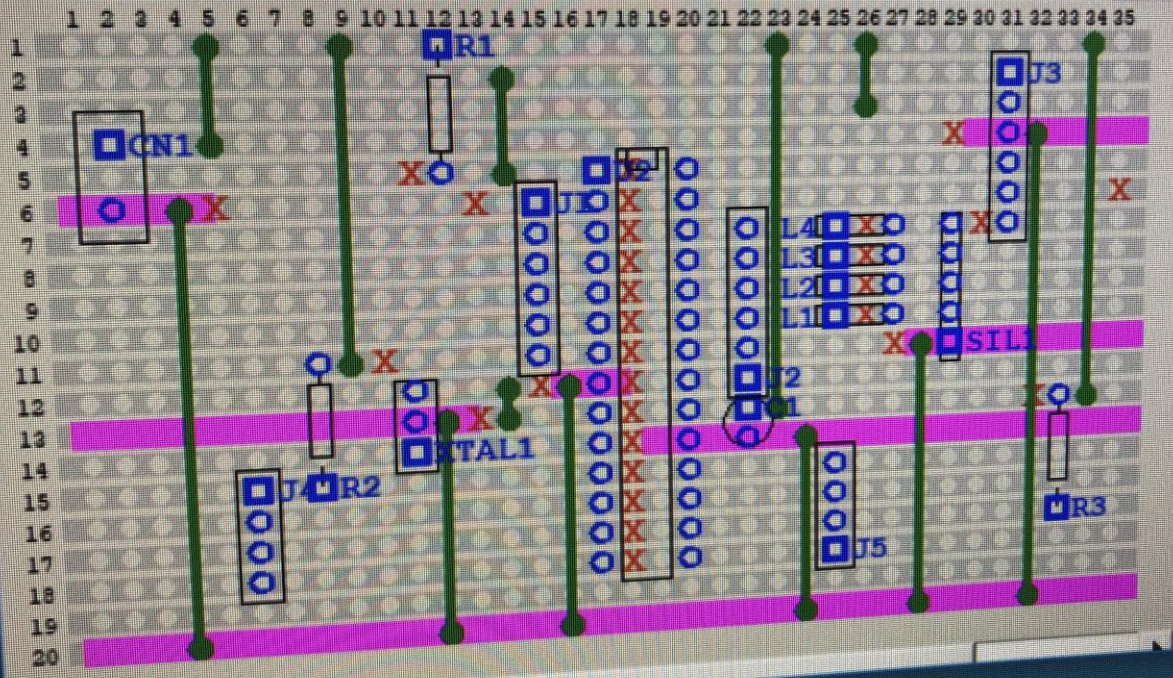

View from copper side (34,7)



學習心態—分享

1. 成果是藉由討論出來的
2. 學習發問的關鍵點
3. 保持積極的態度
4. 不要抄作業！！！！
5. Feedback 的重要性
6. 培養解決問題的能力

Assignment Inbox: ACS133 Physical Systems (ACADEMIC YEAR 2019~20) _77239_1

Assignment Title	Info	Dates	Similarity	Actions
ACS133 Assignment 4 2019-2020		Start 23-Mar-2020 1:00AM Due 10-May-2020 11:59PM Post 24-May-2020 12:00AM	8% 	Submit View 

190177636

ACS133

Task 1

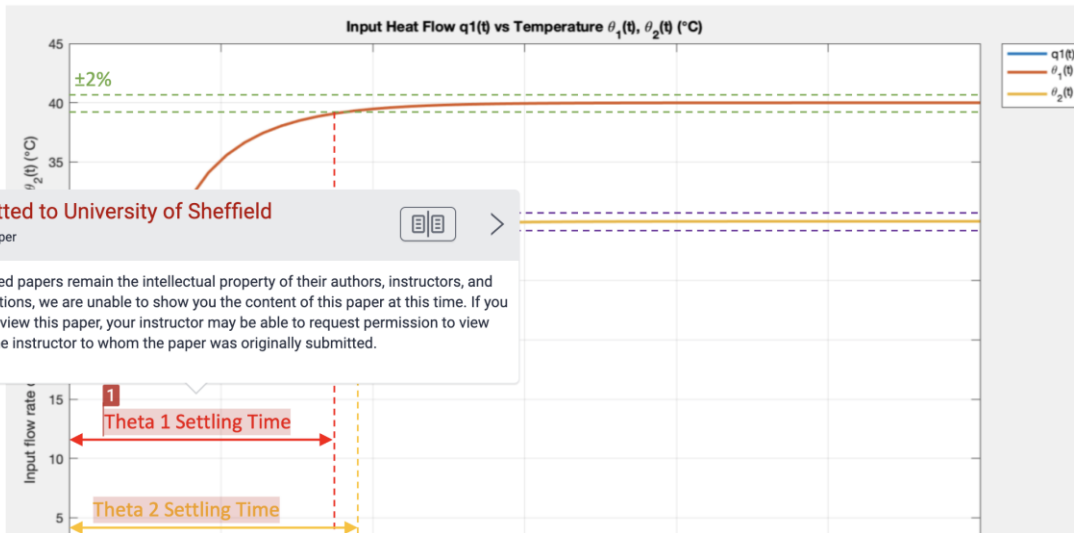

< Submitted to University of Sheffield >

Student Paper

Because submitted papers remain the intellectual property of their authors, instructors, and respective institutions, we are unable to show you the content of this paper at this time. If you would still like to view this paper, your instructor may be able to request permission to view the paper from the instructor to whom the paper was originally submitted.

Match Overview

8%

Match 1 of 17

1 Submitted to University...
Student Paper

8% >

Navigation icons: Home, Chat, 8, List, Filter, Download, Info

Only 5% similarity
2% is the teacher's name

OMG 😨

2415017

SFPH-2W

Physics 1

Gas Laws

2019,01,18

Scott Jones

學習心態—分享

1. 成果是藉由討論出來的
2. 學習發問的關鍵點
3. 保持積極的態度
4. 不要抄作業！！！！
5. Feedback 的重要性
6. 培養解決問題的能力

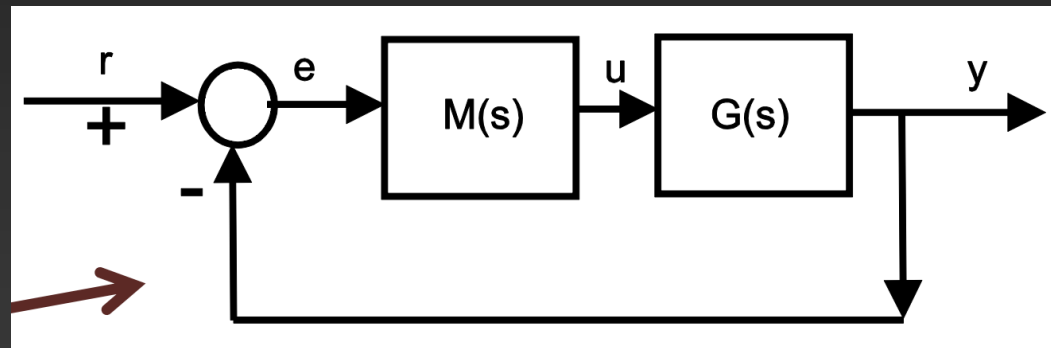
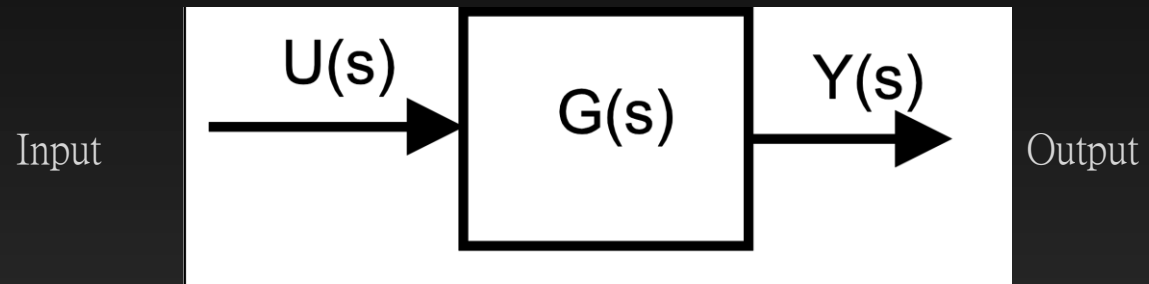

Feedback

Student Registration No: 190177636

Marking Criterion/Comments	Marks
Question 1: clear explanation, appropriate examples and justification.	4/5
Question 2: clear, step-by-step procedure, explanation provided, evidence of understanding of the process.	11/12
Question 3: clear, step-by-step procedure, evidence of understanding of the process involved in obtaining the standard and canonical forms of a Boolean expressions/ functions.	5/8
Question 4: clear procedure description and simplification method used, understanding of combinational circuit design and analysis.	10/12
Question 5: understanding of problem formulation, appropriate approach taken, clear and correct circuit design.	6/16
Question 6: clear procedure description, use of Karnaugh maps, evidence of understanding (comments, explanation), clear and correct circuit design.	18/22
Question 7: understanding of problem formulation, appropriate approach taken, clear explanation including on how the buzzer works and correct circuit design.	20/25
Total	74/100

Feedback:

Good work!

Pay attention to how you write your statements. For example, this - 'If C = 0, output ≥ 5 ' in Q5 is incorrect. Output of a digital circuit can only be either a '0' or a '1', not ≥ 5 ! Also explanation is unclear. Output expression and circuit is incorrect.

Q6, circuits should have NAND gates only!

學習心態—分享

1. 成果是藉由討論出來的
2. 學習發問的關鍵點
3. 保持積極的態度
4. 不要抄作業！！！！
5. Feedback 的重要性
6. 培養解決問題的能力

If you choose to be an engineer

**Your Life is
Already [REDACTED]**

(5hr study /day)



The End

謝謝大家



LANCASTER
UNIVERSITY

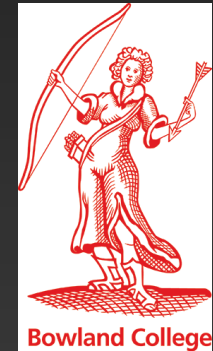

Collegiate System



Collegiate System



ACCOMMODATION



Kitchen

College View



Tour around the campus





Library



Afternoon Break

Introduction to the University of Surrey



Our Location

Located in the UK in
the prosperous
South-East, just
outside of London

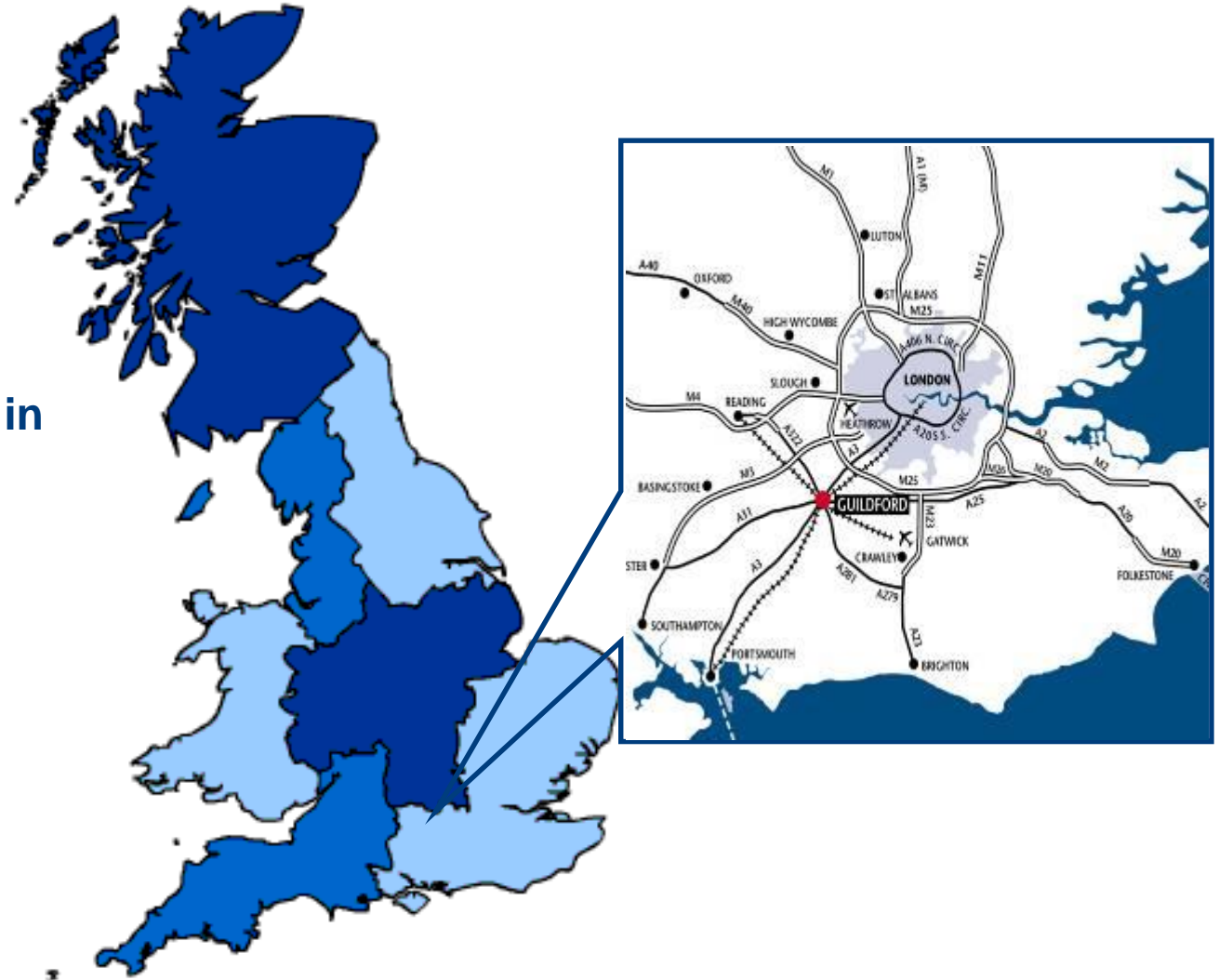

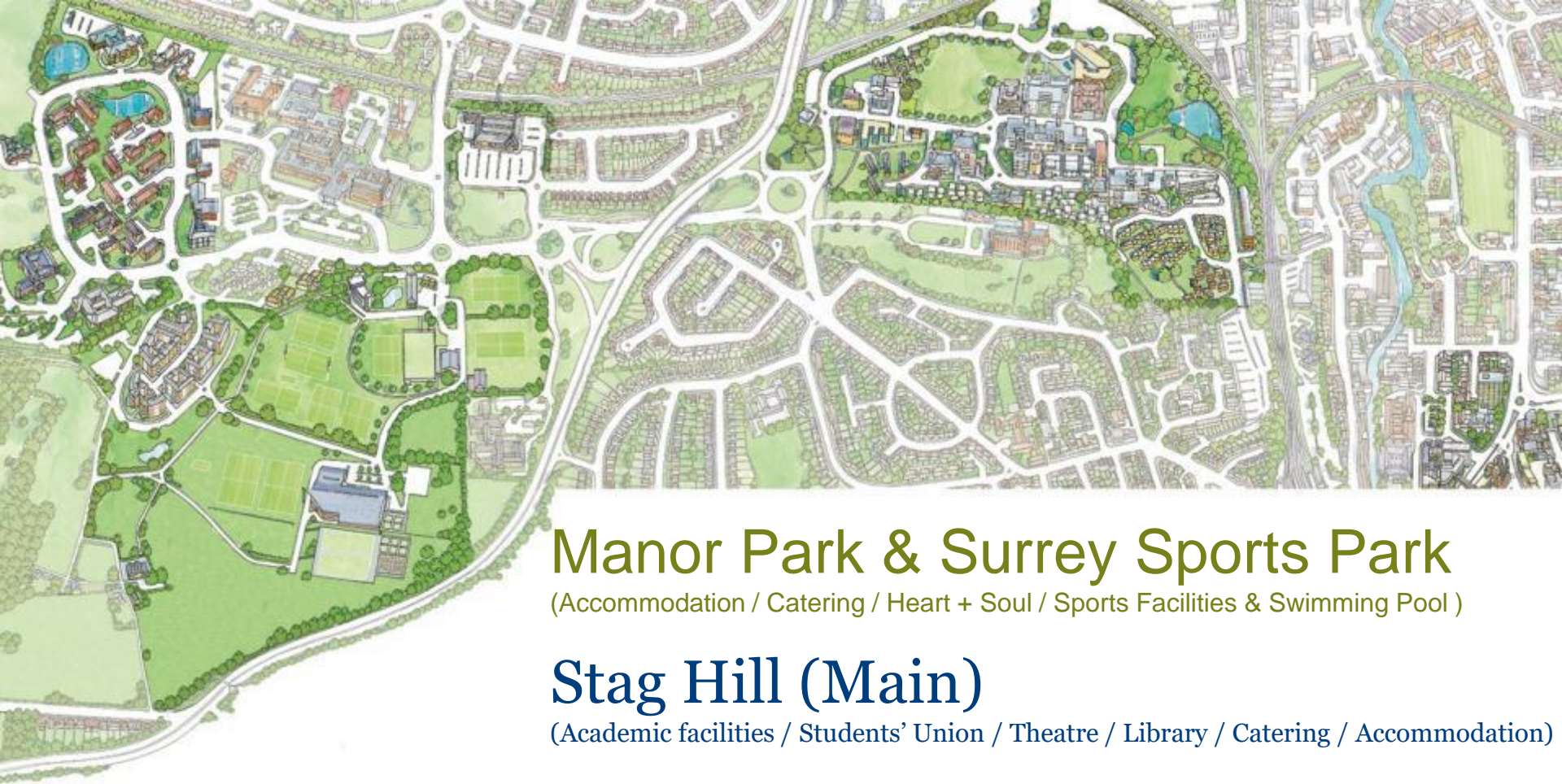

Manor Park & Surrey Sports Park

(Accommodation / Catering / Heart + Soul / Sports Facilities & Swimming Pool)

Stag Hill (Main)

(Academic facilities / Students' Union / Theatre / Library / Catering / Accommodation)

Guildford Rail Station

Guildford Town Centre

Guildford | an historic town for an historic University

‘The safest county in England’

– *The Home Office*

**Beautiful surroundings within
Guildford and its countryside**

34 mins to London by train

**Close to Gatwick &
Heathrow airports**



Guildford town centre

- Town centre is 10-minute stroll from campus
- Shopping
- Guildford high street
- Farmers' market
- Three shopping centres
-



Faculty of Arts and Social Sciences

- Business Management, Economics, Finance, Marketing, HR
- Law
- Hospitality and Tourism
- English and Languages
- Performing and Visual Arts
- Politics

Faculty of Engineering and Physical Sciences

- Aerospace, Chemical, Civil, Electronic and Electrical Engineering
- Computing, Maths, Physics

Faculty of Health and Medical Sciences

- Biosciences
- Chemistry
- Nutrition and Food Science
- Psychology
- Sport and Exercise Science
- Veterinary Medicine

Professional Training Placement

- Undergraduate students can spend **12 months working during year 3**
- Support before, during and after the placement
- Academic relevance – theory into practice
- Real and relevant experience, excellent networking opportunity
- Opportunity to work in the UK or overseas
- Only £1800 tuition fee for the year
- 2300+ partner organisations
- Often paid placement





Global Graduate Award in Languages

Free study in **10** foreign languages and English for Academic purposes

10 credits per level (in addition to degree credits)

- **French** (6 levels)
- **Spanish** (5 levels)
- **German** (5 levels)
- **Italian** (3 levels)
- **Japanese** (2 levels)
- **Portuguese** (2 levels)
- **Mandarin Chinese** (2 levels)
- **Arabic** (2 levels)
- **Russian** (1 level)
- **Korean** (1 level)

International Student Support

- International Student Support team
 - Immigration, visa issues, pre-departure information and international student welfare
- Meet and Greet
 - With the help of current Surrey students, we will meet you at either Heathrow or Gatwick airports on selected days and help you travel to the campus
- Orientation Programme (first week)
 - Welcome talk, workshops, welcome reception & dinner and trips to local places of interest



A Beautiful Place to Live





University of Surrey



LIBRARY TOUR

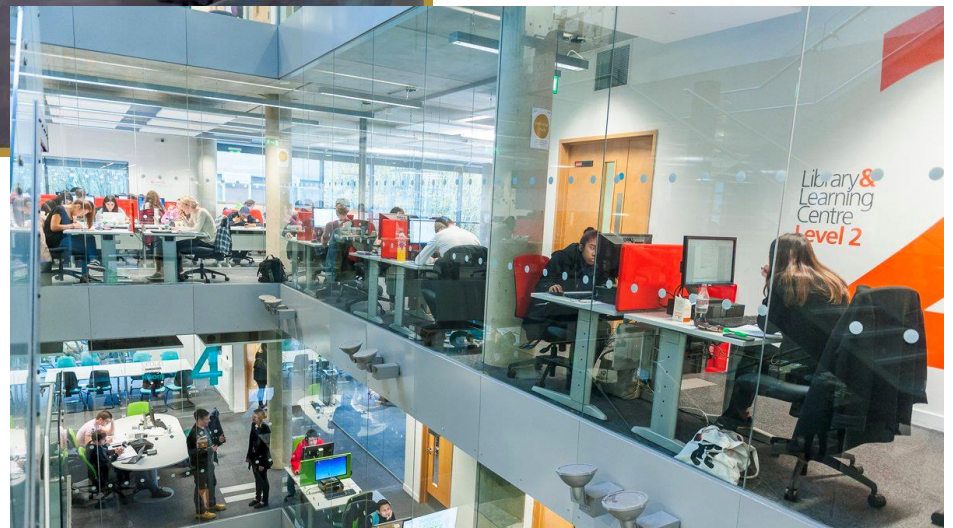

All international students are guaranteed accommodation for the first year of study*.

- 50% of our rooms have en-suite shower and toilet facilities;
- Students share a kitchen-dining room, close to bedrooms;
- Unlimited free broadband and a telephone service with cheap external calls and free internal calls in all rooms;



Surrey Sports Park



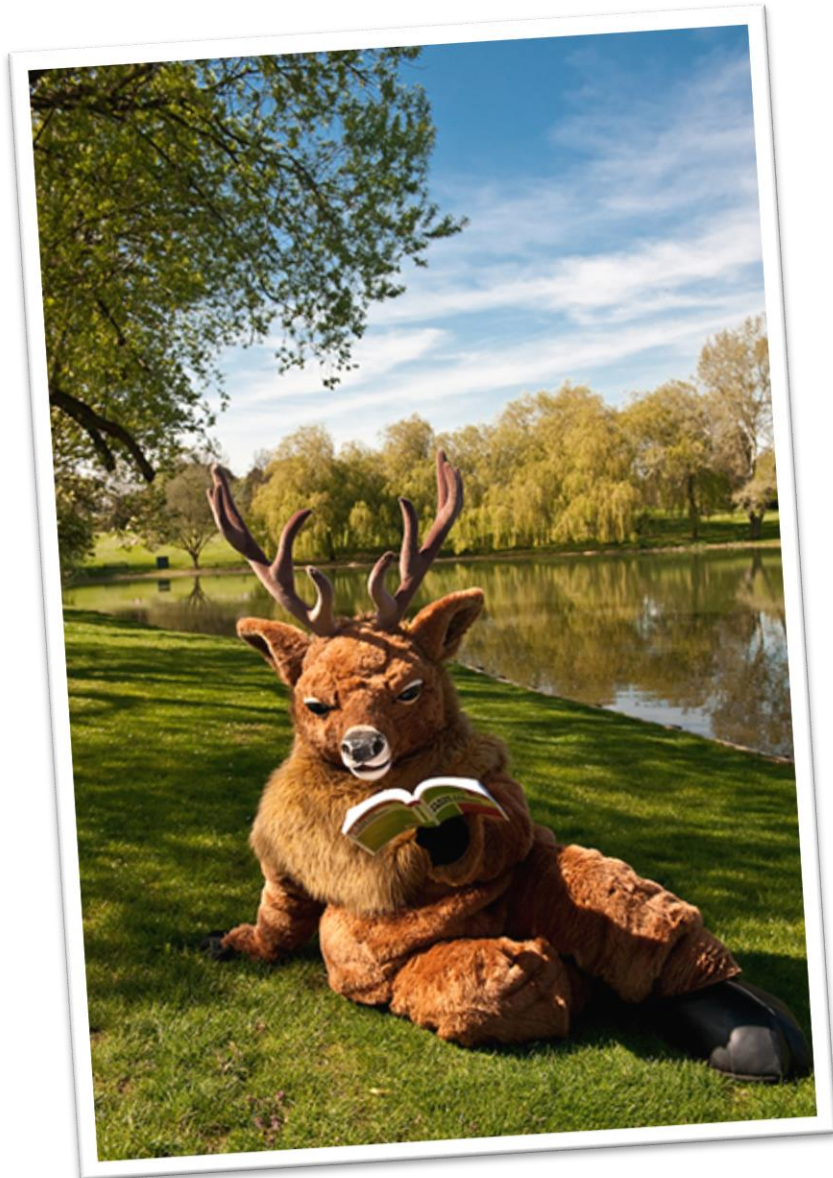

Any questions?